

DESIGN AND IMPLEMENTATION OF AN AUTOMATIC SOLAR TRACKING SYSTEM FOR A SOLAR THERMAL GENERATOR

Camacás Pérez Gerson Bolívar.
Carrera de Ingeniería en Mantenimiento Eléctrico
Technical University of North, Av. 17 de julio 5-21 Ibarra
gerson_electricalwork@outlook.com

Resumen— The present research project consists of the design and implementation of an automatic solar tracking system for a thermo solar generator from the Technical University of North located in the facilities of the Engineering in Electrical Maintenance. It describes the implementation of a system based on astronomical positioning equations that will allow to know the position of the sun at each hour of the day, the automation system was designed and programmed using Arduino as the main controller and Labview as a graphical interface for visualization of the data. The mobility of the system is done in a degree of freedom following the movement of the sun of greater coverage which is, from East to West. The mechanical system consists of tensioning wires located at the ends of the generator, which are picked up by an AC motor to give mobility according to the direction and position ordered by the main controller.

Index of Terms - Arduino, automatic system, solar thermal generator, solar tracker.

I. INTRODUCTION

El The sun is a source of inexhaustible energy, the use of its heat has inspired the most brilliant minds throughout history; How to harness this energy and the construction of pickup devices became topics of continuous development and evolution.

In 1867 the Swiss scientist Horace de Saussure developed the first solar collector. More recently, a little more than 100 years ago, French scientist Auguste Mouchout used heat from a solar collector to produce steam and move a motor.

This is how the great scientific production and the advances of the technology led to the industrialization of the use of solar energy, from the construction of houses with the appropriate

orientation to capture the light, to the modern thin photovoltaic cells, the human being takes advantage of the Solar radiation to meet their energy needs [8]. The latest systems to improve heat collection have solar trackers, which increases the efficiency of the collectors.

At present, different types of solar trackers are known whose purpose is to improve the use of solar energy. Some studies generally say that azimuthal tracking picks up 10% to 20% more than fixed structures and can reach up to 25% in some cases. Among the different types of followers on two axes there are variations of between 30% and 45% increase in production compared to fixed installations [10]. At the Technical Education School of the Technical University of North, the main university center of zone one of Ecuador, has been promoted the investigation and the use of renewable energies. A specific example is shown in the laboratory of the Electrical Maintenance Engineering Career (CIMANELE), where there is a decentralized system of solar thermal generation of parabolic disk and Stirling motor that stays in fixed position and for a certain time uses solar radiation To its maximum splendor to generate 12 V in direct current and to feed an application that uses a UV lamp to purify water of a vessel. It is here, where the present work will focus on strengthening the solar light capture system by implementing an automatic solar tracking system.

Of the types of followers investigated, the follower chosen to be implemented should be primarily of active type because for the rotation movement a motor controlled by an electronic

board in this case Arduino is used which is a more economical alternative in comparison to other automatons like the one PLC.

The solar tracker will be of a single degree of freedom in the horizontal axis of the capturing surface because the Ecuador is a country privileged by the perpendicular incidence of the rays of the sun.

The tracking algorithm will be an astronomical one, which, despite having greater difficulty in its implementation, provides greater reliability in terms of tracking the sun, which guarantees that the system will not depend on the climatic conditions for its operation.

II. DESIGN AND CONSTRUCTION OF MECHANICAL SOLAR TRACKING SYSTEM

The design of a follower whose movement is done with tensioning cables that allow tilting the parabolic disk according to the daily or azimuthal rotation, East-West.

In Fig. 1 the mechanical design, where the main components are indicated, is represented by a simplified schematic, the scheme was performed using SketchUp software.

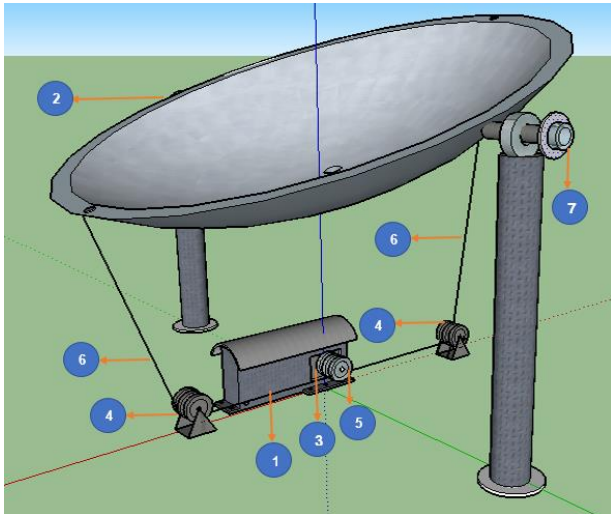

Fig. 1. Simplified diagram of the solar tracker designed (without scale).

TABLE I
MAIN COMPONENTS OF MECHANICAL DESIGN

1	Engine mount
2	Solar Thermal Generator
3	AC motor with gearbox
4	Pulleys
5	Pulley for motor shaft
6	Tensioning cable
7	Coupling for position sensor

A. Engine mount

This metal support has been designed with the purpose of positioning the AC motor with its respective gearbox, so that it is correctly positioned, in addition the base serves as support to avoid contact with the ground, consists of perforations necessary to keep it fixed, Providing security and stability to the system in general. In Figure 2 we can see the design of the base for the motor realized in SolidWorks.

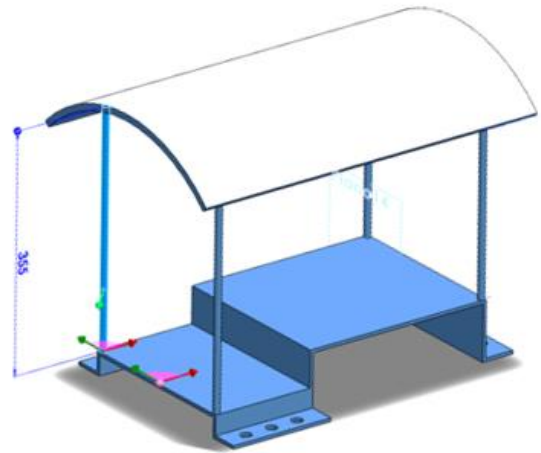

Fig. 2. Motor View 3D Base.

B. Solar thermal generator

The mechanical design of the solar tracker is for a thermo solar generator, which is located at CIMANELE facilities.



Fig. 3. Solar thermal generator of parabolic disk and stirling motor.

This generator is formed by a parabolic disk collector, which captures the solar radiation, which is transmitted in the form of heat to a Stirling type motor and by means of a thermodynamic cycle this caloric energy is transformed into mechanics, the motor is connected to An alternator to convert the mechanical energy into electrical, the characteristics of this generator are observed in Table II.

TABLE II
GENERAL CHARACTERISTICS OF THE GENERATOR TERMO SOLAR

Physical characteristics	
Diameter of the parabolic disk	4m
Height of support columns	2 m 28 cm
Mobility provided by the rotary axis of the parabolic disk	60° from both sides
Operating Characteristics	
Voltage delivered by the stirling engine in vacuum	12 V
Irradiance of operation	1.162 W/m ²
Operating temperature	347 °C

C. Motor

Previously, before sizing the engine, it was analyzed to implement a system where the force applied is at the ends of the parabolic disk, to determine the amount of force required a measuring instrument called dynamometer was used, which is a tool that from the Changes in the elasticity of a spring with a certain calibration, allows the calculation of the weight of a body or the

measurement of a force, the measurement scheme can be seen in Fig. 4.

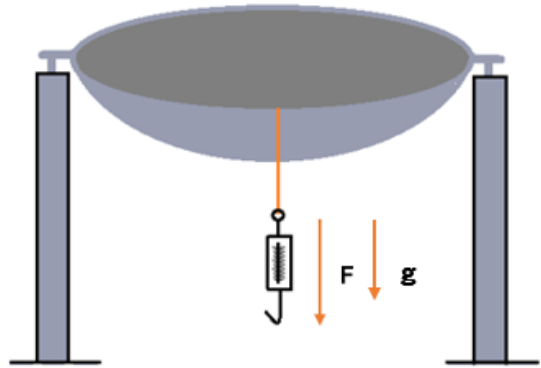

Fig. 4. Force measurement diagram.

The measurement obtained in kgf is of 10.5 kg in each one of the ends of the parabolic disk, transforming to Newton to determine the necessary force to be applied remains the following.

The mass is = 10.5 kg, the acceleration is $g = 9.8 \text{ m/s}^2$

$$F = \text{mass} \times \text{gravity}$$

$$F = 10.5 \text{ kg} \times 9.8 \text{ m/s}^2$$

$$F = 102.9 \text{ N}$$

$$N = [\text{kgm/s}^2]$$

The force was measured by tilting the parabolic disk to the maximum but it is considered a maximum displacement of one meter in each side for that reason the torque would be.

$$F = \text{applied force}$$

$$[\text{N}]$$

$$d = \text{travel distance} [\text{m}]$$

$$T = F \times d$$

$$T = 102.9 \text{ N} \times 1\text{m}$$

$$T = 102.9 \text{ Nm}$$

A three-phase induction AC motor with a power of 1 HP = 746 W at 1660 rpm is available, so that the system works properly, its movement must be slow, ie the rpm must be lower than the rated value Of the motor, so it was necessary to implement a geared gearbox Fig. 5 whose purpose is to decrease

the rpm and thus to obtain a smoother movement and in turn to increase the torque of the motor, since the one that owns originally is not enough to move to the parabolic disc, the characteristics of the reducer box are observed in Table III.

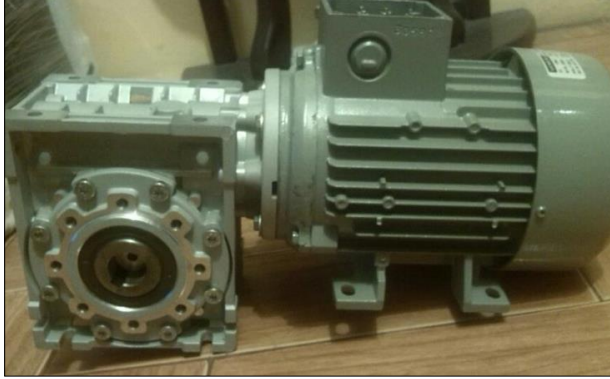

Fig. 5. AC motor with gearbox.

TABLE III
CHARACTERISTICS SPEED REDUCTION BOX

Revolutions	1800 rpm
power	1 HP
Speed Required	60 rpm
real speed	1660 rpm
Engine Frame	80
maximum torque	166 Nm
i used	25
i calculated	27, 666
Calculated speed Ns1	66,4 rpm
Calculated Torque	107,293 Nm
Service Factor (Fs)	1,5471

D. Pulleys

The pulleys were implemented to the system after the first tests carried out only with the motor and its axis of rotation, to distribute the load of the weight of the thermo solar generator two pulleys for motor of two channels properly adapted to be embedded in the floor, thanks to the pulleys Fig. 6 it is possible to pull the parabolic disk with an important component parallel to the movement that will make the parabolic disk in this way besides facilitating the mobility of the parabolic disk serve as a point of support and subjection to the presence of climatic changes .



Fig. 6. Pulleys used in the mechanism.

E. Tensioning cables

For the mobility of the parabolic disk, tensioning cables have been used which, due to their characteristics, are optimal for the function they are going to carry out, since they carry a load of up to 154 kg.

F. Coupling for the position sensor

For the correct operation of the system, the main variable to be measured is the position in which the parabolic disk is located, thanks to the accelerometer this measurement can be obtained in degrees. It is necessary to adapt the position sensor ie the accelerometer to the axis of mobility of the parabolic disk, for it was designed a metal coupling with a plastic housing so that the sensor is protected from the climatic conditions as seen in Fig. 7.



Fig. 7. Coupling and protective housing for the accelerometer.

III. SOLAR TRACKING ALGORITHM

The system tracking algorithm is based on astronomical positioning equations, which allow to know the position of the sun at each moment of the day, the main equation is the one that calculates the azimuth angle (1), since the system is a solar tracker Of a single degree of freedom with azimuth angle tracking.

$$az = \arcsin \frac{\cos(\delta)\sin(\omega)}{\cos(\epsilon)} \quad (1)$$

The results shown in Table IV are those corresponding to the azimuth tracking angle for May 31, 2016.

TABLE IV
RESULTS OF THE AZIMUTHAL ANGLE CALCULATION

Time of the day	Azimuth angle in degrees
6	21,91
7	22,31
8	24,24
9	28,39
10	36,5
11	53,02
12	84,10
13	118,97
14	139,51
15	149,62
16	154,75
17	157,26
18	158,10

IV. ELECTRONIC DESIGN OF THE SOLAR TRACKING

A. Introduction

The design of the solar tracker is based mainly on the creation of a programming algorithm using an Arduino electronic board, the program to be developed will perform the calculations using preset formulas for the correct orientation and positioning of the parabolic disk towards the sun throughout the day.

The electronic circuit sends the activation and deactivation signals, through the use of relays to a frequency inverter, so that the AC motor made the correct movement of the parabolic disk towards the sun, because the formulas give us a result of position. At angles it is necessary to feed the signal through an analog accelerometer, which will confirm the correct position and allow us to know

at which angle the pickup surface is oriented.

A graphical interface was used using Labview where the variables and their behavior can be observed, the user can use this interface to correct certain parameters manually from a computer.

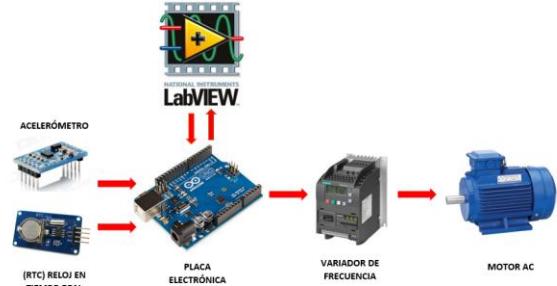

Fig. 8. Basic diagram of the solar tracker.

B. Electronic circuit

This circuit consists of each of the electronic components that are part of the automatic solar tracking system, which includes input, control and communication devices.

Fig. 9 shows the board designed in the PCB wizard software for the solar tracking system, which serves as a general outline of the components that were necessary for its design.

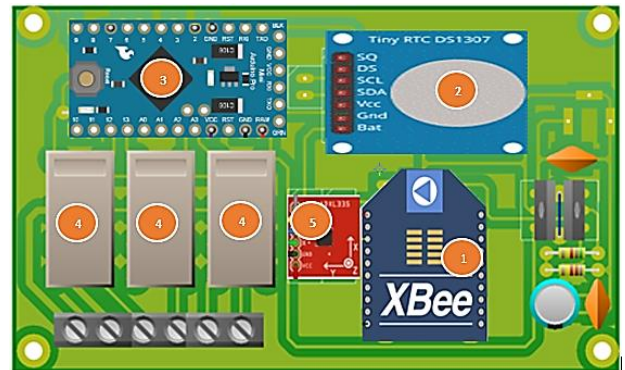

Fig. 9. Electronic control board.

Table V lists the elements used for the control board.

TABLE IV
COMPONENTS OF THE ELECTRONIC BOARD

1	3 Axis Accelerometer GY-61 ADXL335
2	Real Time Clock (RTC) DS1307
3	Arduino Pro Mini
4	Relays
5	Xbee pro S1

C. Frequency Inverter

The control system for the mobility of the parabolic disk requires a power stage that allows controlling the AC motor, and the frequency inverter is a system that allows the control of the rotational speed of the motor, start up and additionally the turning inversion .

The frequency inverters have working modes either manual or automatic, according to the needs of the process, and can be handled by computer, PLC, digital signals or manually.

The drive was purchased according to the characteristics of the AC motor with a capacity of 1 hp for more details on its characteristics see Table VI.

TABLE VI
CHARACTERISTICS FREQUENCY INVERTER

Model	Sinamics V20
Operating Voltage	200-230V
Rated input current	10 A
Rated Output Current	4.2 A
Frequency of output	0-63 Hz
power	1hp
Voltage range	200 V a 240 V CA (tolerancia: de -10 % a +10 %) 47 Hz a 63 Hz There is a reduction of current with input voltages or switching frequencies greater than 230 V / 8kHz.
Protection class	IP 20
Maximum Humidity Level	95 % (without condensation)

D. Electrical circuit

The electrical connection diagram of both the power section and the control part can be seen in Fig. 11.

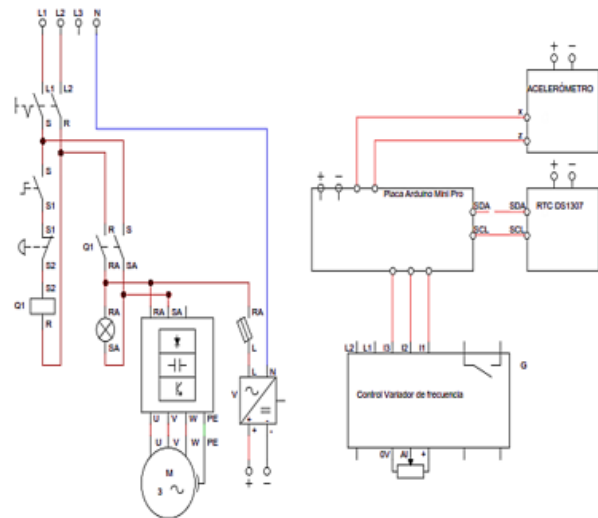

Fig. 10. Electrical connection diagram.

V. PROGRAMMING

The programming of the control device in this case arduino pro mini was realized using the software of its platform of development, whose language of programming is based on C ++.

The basic structure of the arduino programming language is simple and is divided into at least two parts which contain functions, declarations, instructions that will be executed according to the specifications of the program.

The two main stages in which the program is divided are:

A. Declaration of variables setup ()

The part that is responsible for storing the configuration ie the declaration of the variables is the function Setup () Fig. 11, is the first to be executed in the program and once.

This is used either to start or configure the inputs and outputs of the Arduino board or to configure serial communication.

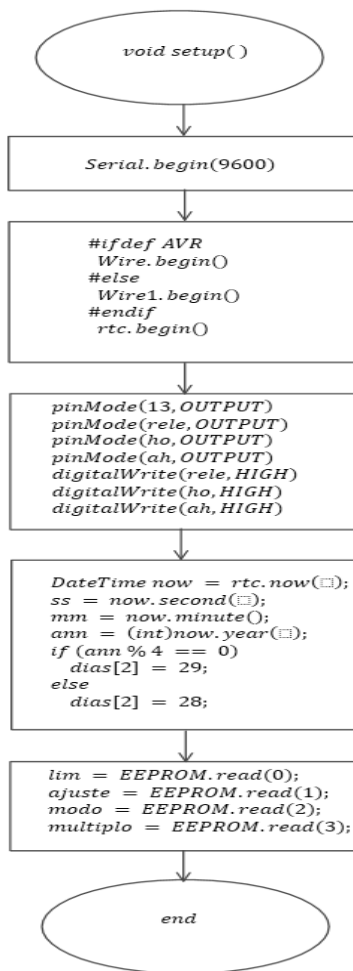

Fig. 11. Flow diagram void setup ().

B. Function Loop ()

After having declared the variables in the Void Setup () function, the Loop () function Fig. 12 allows the program to run in a cyclic way, ie the program will respond continuously to the events that are occurring in the micro controller of the arduino.

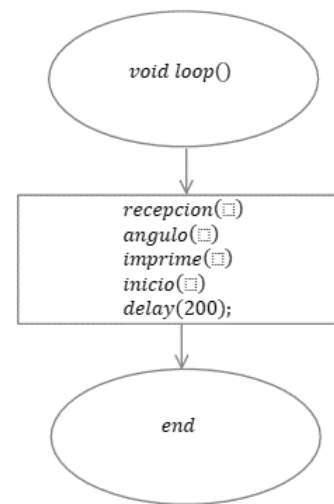

Fig. 12. Flow diagram void loop ().

VI. LABVIEW USER GRAPHIC INTERFACE

The main objective of the program developed in LabVIEW is that it works as a graphical user interface, which will allow entering certain parameters for the correct operation of the system and also to be able to monitor the desired angles, all through a user friendly interface.

Some of the requirements that the software must meet are:

- Allow the entry of certain parameters necessary for the positioning of the thermo solar generator such as: latitude, maximum angle of inclination in the East direction, maximum angle of inclination west direction.
- Receive data from the Arduino electronic board and interpret them for display in the user interface.
- Obtain actual and actual data such as position angles as well as the time and date they are running.

The Labview platform Fig. 13 was used as a viewer and data editor and not as a controller.



Fig. 13. LabVIEW graphical interface.

Among the main parts of the graphical interface are the following.

A. Communication port

The user must select the serial communication port where the Xbee will be connected to later establish the serial communication between the computer and Arduino, the communication speed must be the same in both arduino and LabVIEW.

B. Settings

This section allows to change certain parameters within the programming of the system that will modify the operation of the same according to the needs of the user, then each one of them is described generally.

- Length: length of the place where the solar collector is located.
- Latitude: Latitude of the place where the solar collector is located.
- Limits: are the maximum angles of inclination of the parabolic disk or any system of solar capture both towards the East and the West.
- Adjustment: In case the accelerometer presents an error in the angular value of the position, either because of the distance or due to sensor faults, this adjustment will allow calibration for a better measurement.
- Intervals: The user can choose at what

interval of time he wants the solar tracking to be performed, the intervals range from one minute to one hour.

VII. CONCLUSIONS

The investigation of the different types of solar tracking systems allowed to determine that the most optimum due to the great advantage that Ecuador has in terms of solar resource is the azimuthal horizontal solar tracker with a degree of freedom based on astronomical positioning equations Whose accuracy is within the standards of commercial followers.

The implementation of a simple and easy-to-assemble mechanical system has been achieved that meets the requirements for the solar tracking system in a degree of freedom.

The electronic design using arduino as the main controller fulfilled the necessary requirements showing that arduino can be dynamic, functional and above all economic when it is used in this type of projects of Renewable Energies and automation.

An interface was developed in Labview which, through serial communication with arduino, allows us to monitor the position of the solar collector in real time, in addition Labview allowed to make an editable system and that can be used in any city of the country only by modifying the values of latitude and Length of the place where it is desired to implement this system.

RECOGNITION

A special thanks to God, the supreme being and creator of all things, to my Fathers: Mr. Alfonso Camacás and Mrs. Marilú Pérez, an infinite thanks to Mr. Mauricio Vásquez, director and guide of this research work. Many thanks to each of the teachers and engineers, who contributed with their knowledge and recommendations, Hernán Pérez, Pablo Méndez, Ramiro Flores, Claudio Otero, Leuber Rosa.

REFERENCES

- [1] G Abal, G., & Durañona, V. (2013). *Manual Técnico de Energía Solar Térmica*. Montevideo, Uruguay: Universidad de la República de Uruguay.
- [2] Bishop, R. (2002). *The Mechatronics Handbook*. California, EEUU: Editor in Chief.
- [3] Costas, P. C. (2005). *Montaje e instalación en planta de máquinas industriales, procesos, instrumentos y técnicas básicas de construcción y organización del trabajo*. España: Ideaspropias.
- [4] Chandi Paguay, K. A., & Ruano Vega, E. S. (2015). *Estudio de un sistema de generación termo solar mediante disco reflector parabólico y motor stirling e implementación de un modelo a escala para la alimentación eléctrica de un filtro de purificación de agua con luz ultravioleta (tesis de pregrado)*. Ibarra: Universidad Técnica del Norte.
- [5] Duffie, J and Beckman, W. (2006). *Solar Engineering of Thermal Processes* (3rd ed.). Wiley: ISBN 0471698679.
- [6] Dutch, S. I. (2004). *World Book Online.*, de World Book, Inc.: www.nasa.gov
- [7] Lorenzo, E. (2003). *Retratos de la Conexión fotovoltaica a la red*. Madrid, España: Instituto de energía solar – Universidad Politécnica de Madrid.
- [8] Méndez Muñoz, J. M. (2011). *Energía solar térmica*. Fundación Cofemetal.
- [9] Pintos Lanzuela, C. (2010). *Seguidor Solar Ligero Para Cubiertas (proyecto fin de carrera)*. Madrid, España: Universidad Pontificia Comillas.