

**ACERIA DEL ECUADOR ADELCA**

Referencia: **= PS01**

Responsable: **Edgar Taimal**

TITULO: **Silo de Pesaje**

Fecha: **19 de Marzo 2014.**

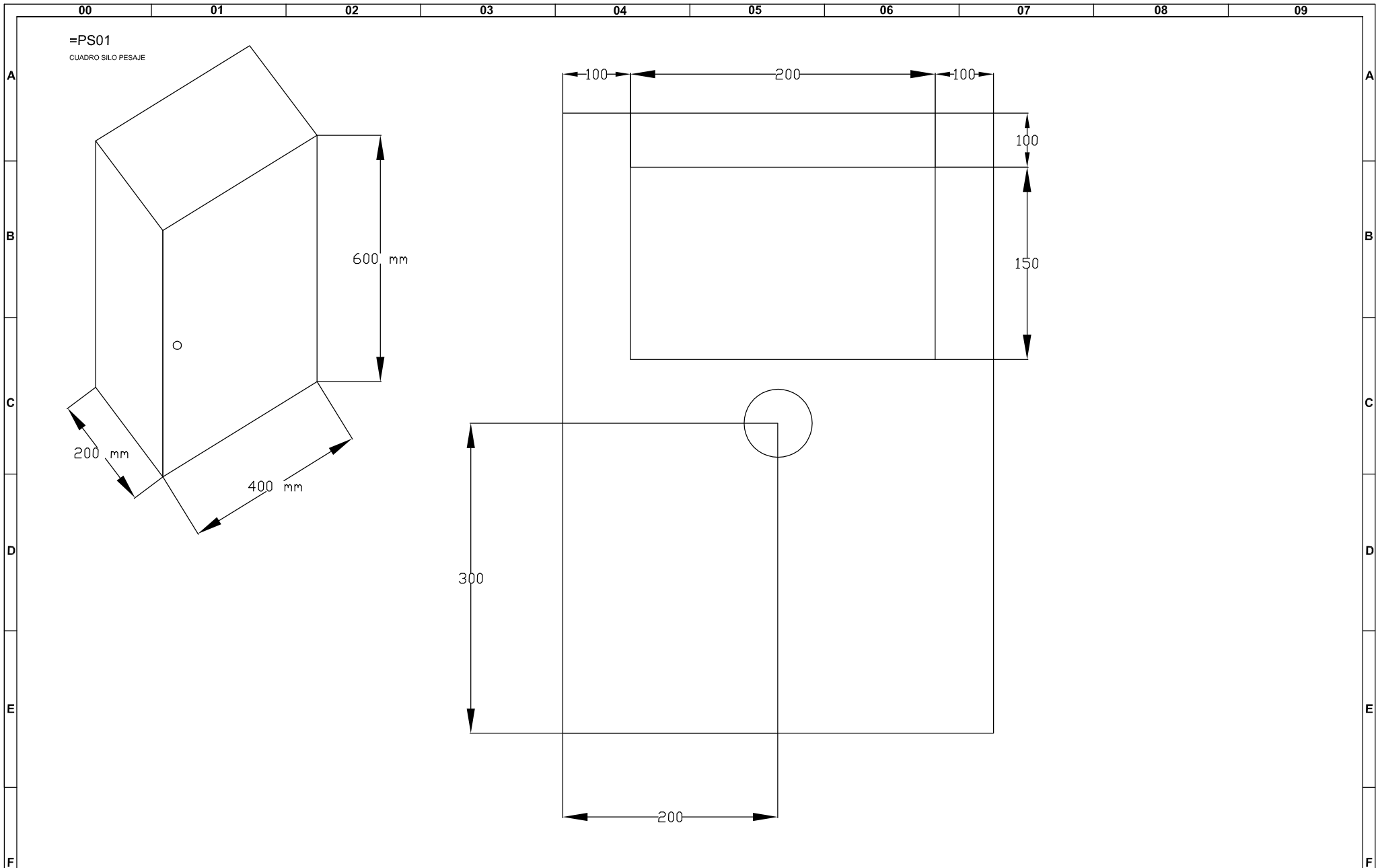

=PS01  
CUADRO SILO PESAJE

600 mm

200 mm

400 mm

100

200

100

100

150

300

200

DATE	19/04/2014
DRAWN	Edgar Tainal
CHECK	Edgar Tainal
Appd.	



ADELCA

TABLERO ELECTRICO

Plano Silo Pesaje

=PS01

SHEET A01	FOLLOW B01
N° SHEETS 13	

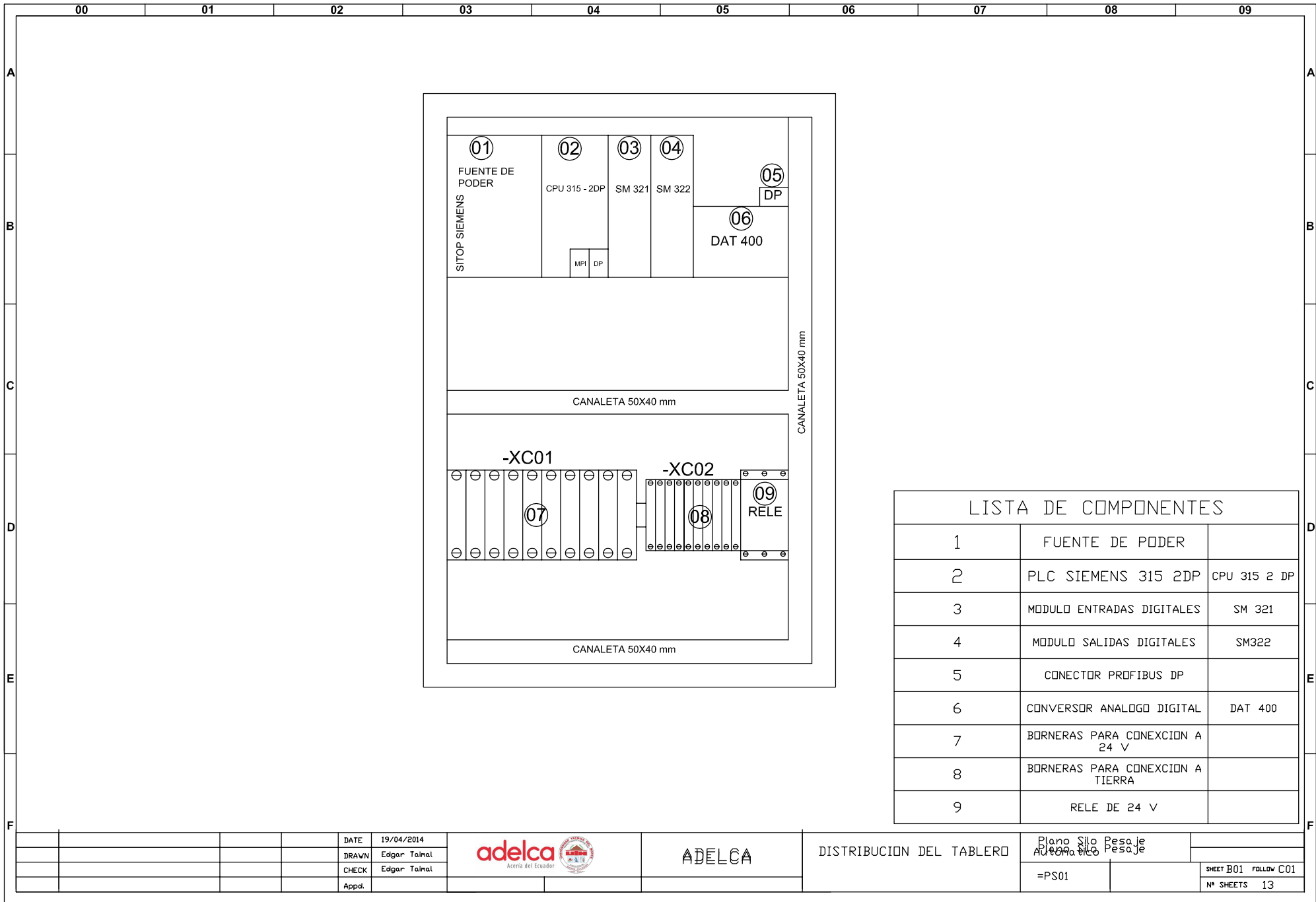

LISTA DE COMPONENTES		
1	FUENTE DE PODER	
2	PLC SIEMENS 315 2DP	CPU 315 2 DP
3	MODULO ENTRADAS DIGITALES	SM 321
4	MODULO SALIDAS DIGITALES	SM322
5	CONECTOR PROFIBUS DP	
6	CONVERSION ANALOGO DIGITAL	DAT 400
7	BORNERAS PARA CONEXION A 24 V	
8	BORNERAS PARA CONEXION A TIERRA	
9	RELE DE 24 V	

DATE	19/04/2014
DRAWN	Edgar Talmal
CHECK	Edgar Talmal
Appd.	



**ADELCA**

DISTRIBUCION DEL TABLERO

Plano Silo Pesaje  
 Auto pesaje  
 =PS01

SHEET B01	FOLLOW C01
N° SHEETS	13



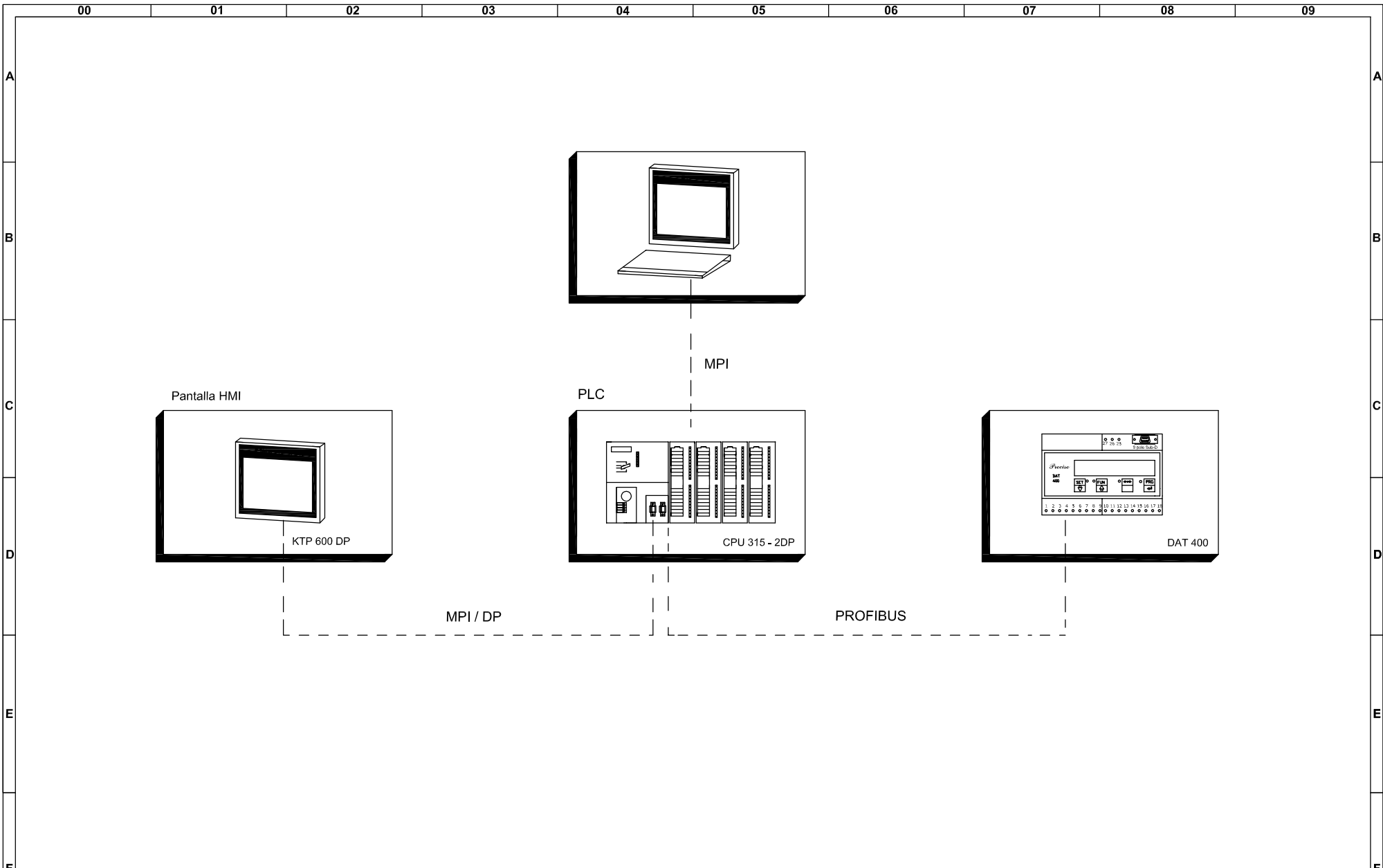

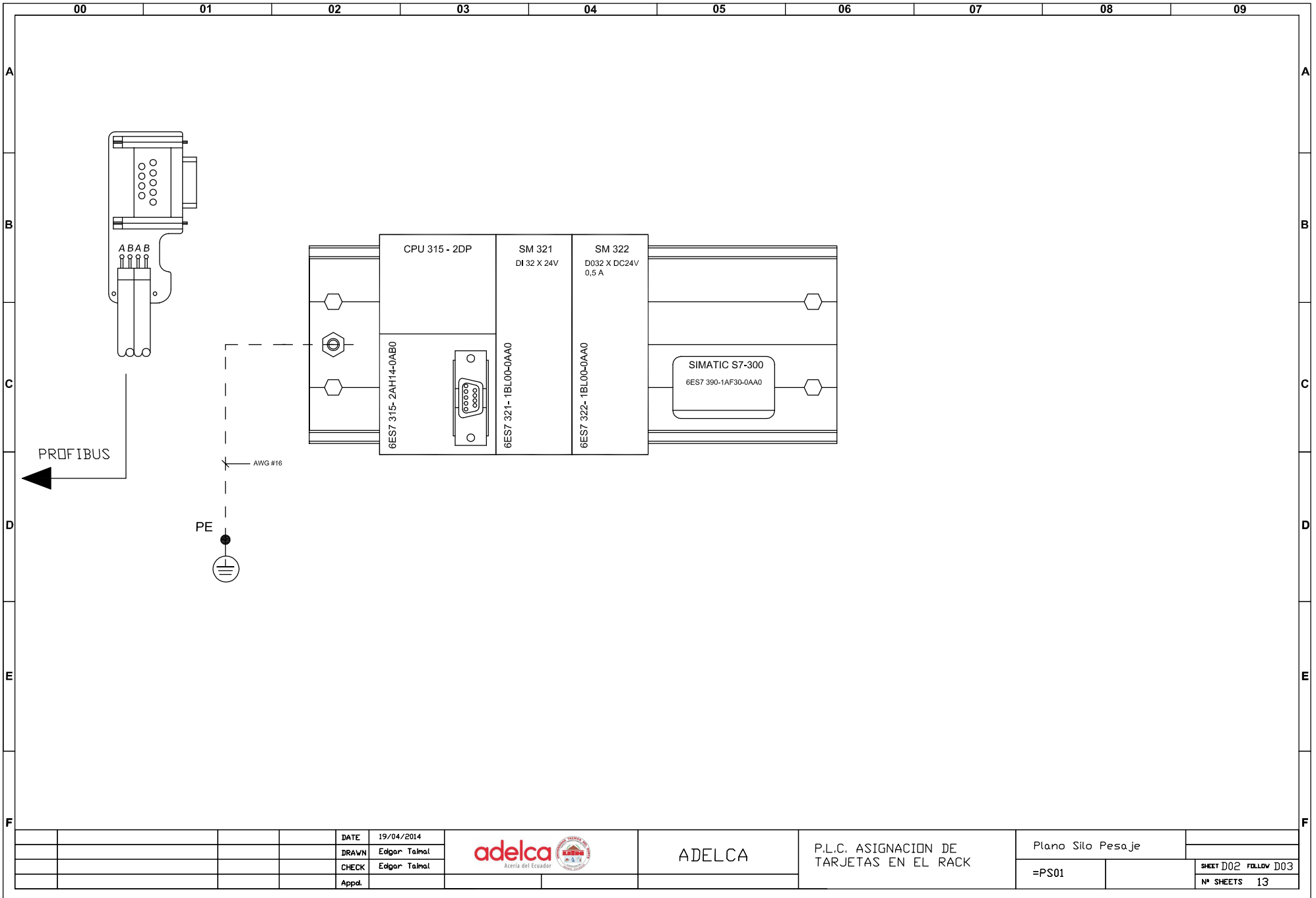

				DATE	19/04/2014		ADELCA	DIAGRAMA DE ENLACES DE COMUNICACION CON PLC, PC, HMI, DAT 400	Plano Silo Pesaje		
			DRAWN	Edgar Taimal					=PS01	SHEET D01 FOLLOW D02	
			CHECK	Edgar Taimal						N° SHEETS 13	
			Appd.								

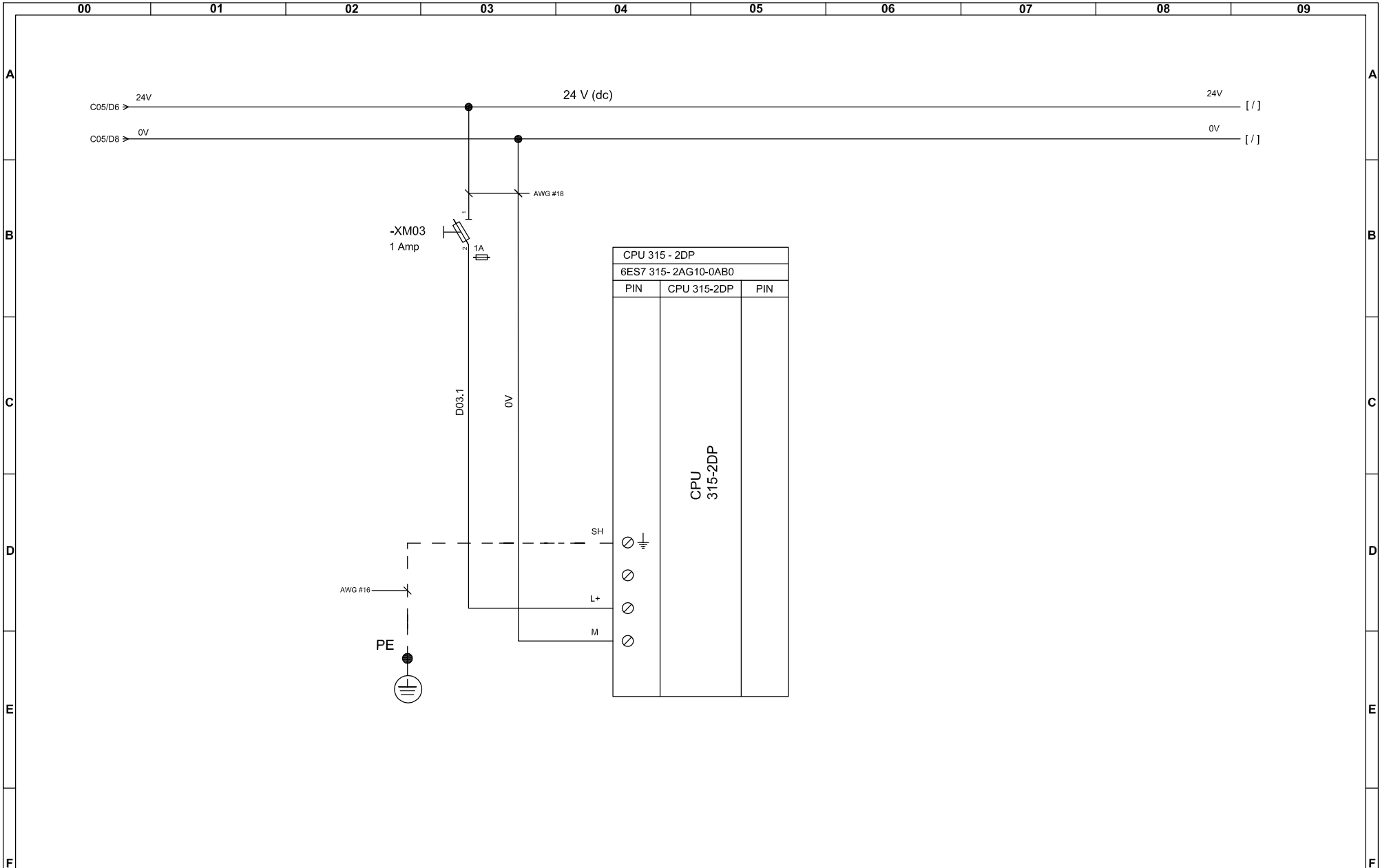

				DATE	19/04/2014		ADELCA	P.L.C. ASIGNACION DE TARJETAS EN EL RACK	Plano Silo Pesaje		
			DRAWN	Edgar Tainal	=PS01				SHEET D02 FOLLOW D03		
			CHECK	Edgar Tainal						N° SHEETS 13	
			Appd.								



				DATE	19/04/2014		ADELCA	P.L.C. ALIMENTACIÓN A LAS TARJETAS	Plano Silo Pesaje		
			DRAWN	Edgar Talmal	=PS01					SHEET D03 FOLLOW D04	
			CHECK	Edgar Talmal						Nº SHEETS 13	
			Appd.								





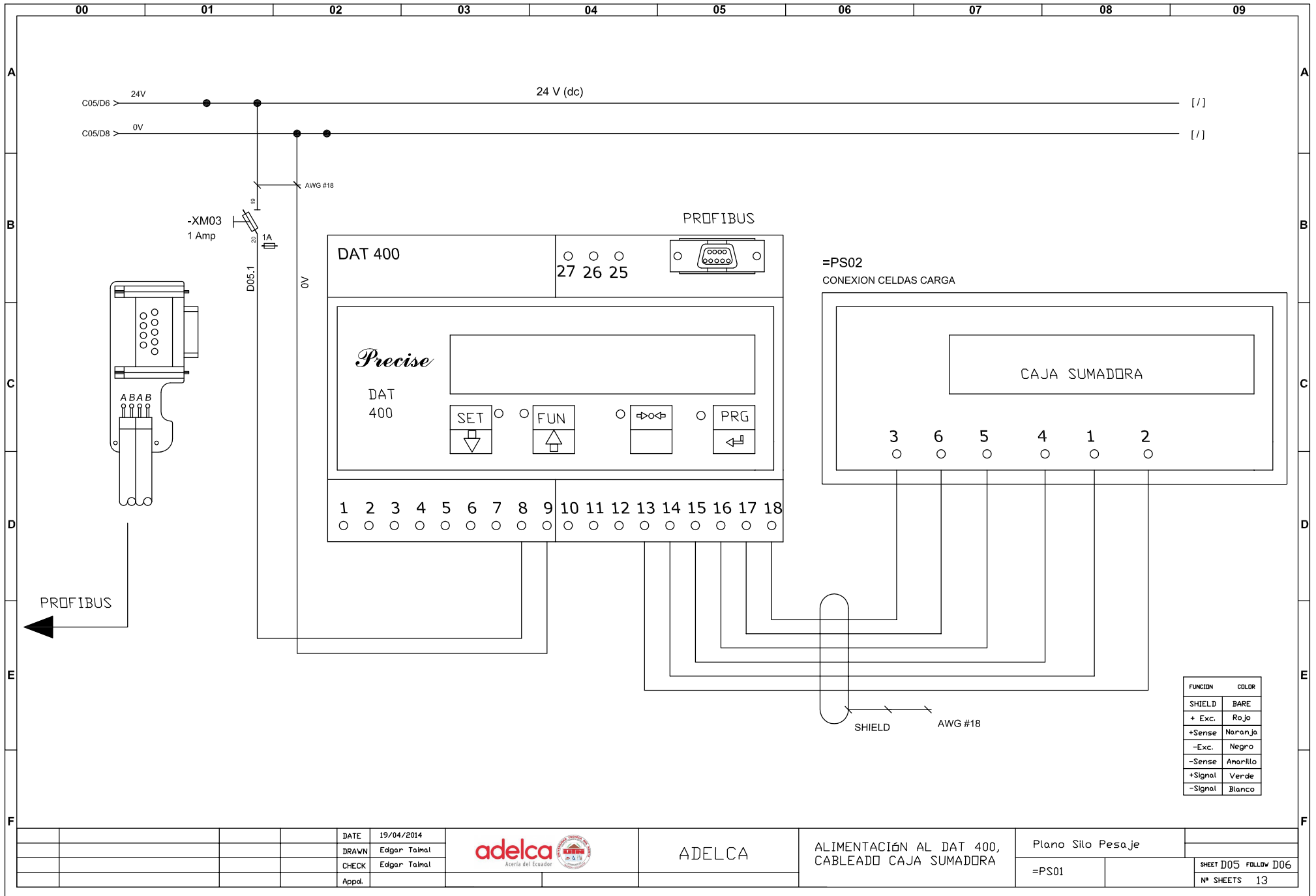

FUNCION	COLOR
SHIELD	BARE
+ Exc.	Rojo
+Sense	Naranja
-Exc.	Negro
-Sense	Amarillo
+Signal	Verde
-Signal	Bianco

DATE	19/04/2014
DRAWN	Edgar Taimal
CHECK	Edgar Taimal
Appd.	



ADELCA



ALIMENTACIÓN AL DAT 400,  
CABLEADO CAJA SUMADORA

Plano Silo Pesaje

=PS01

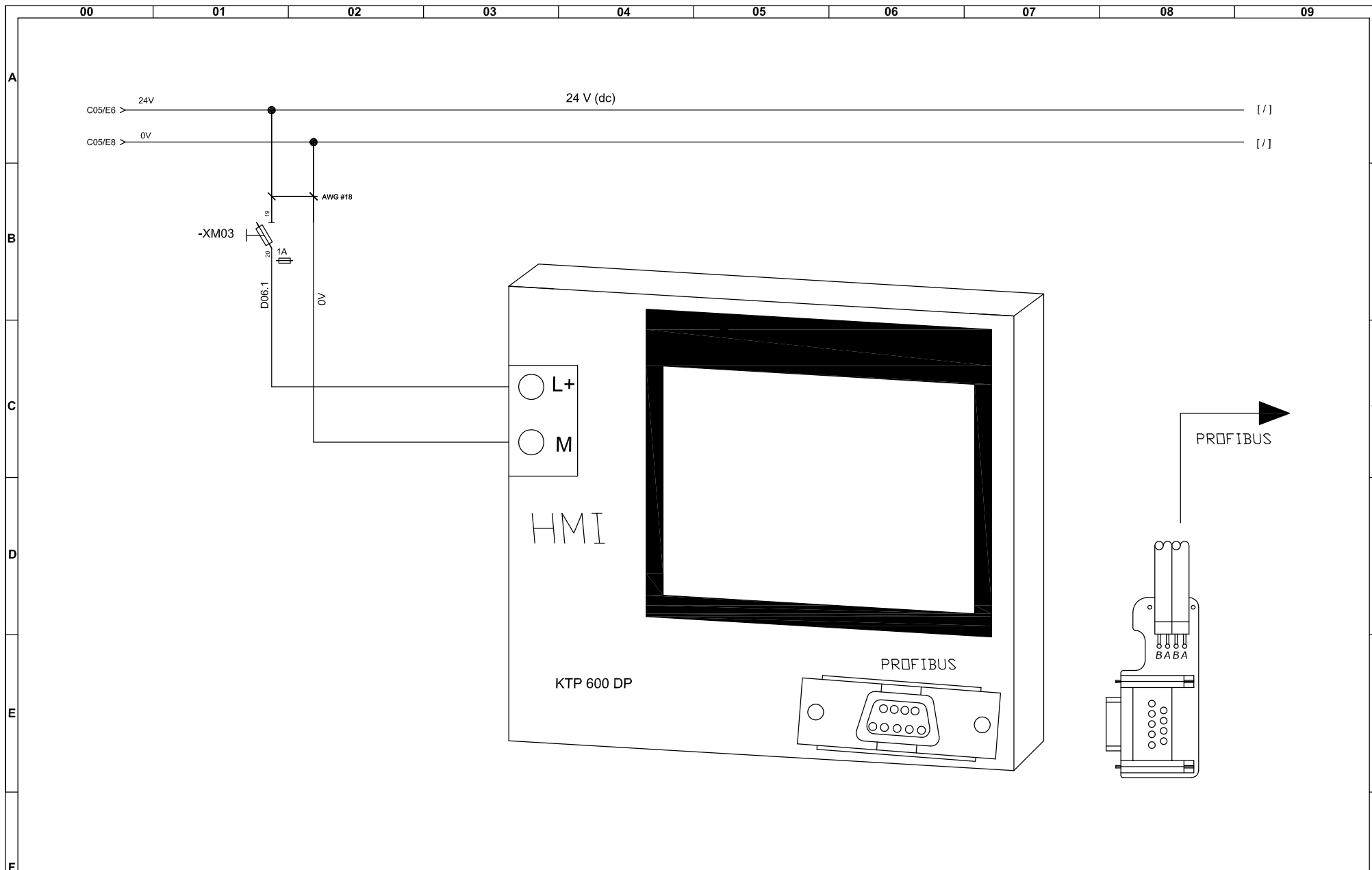
SHEET D05 FOLLOW D06  
N° SHEETS 13



				DATE	19/04/2014			ALIMENTACION HMI KTP 600	Plano Silo Pesaje				
			DRAWN	Edgar Talmat									
			CHECK	Edgar Talmat									
			Appd.										
									=PS01		SHEET D06 FOLLOW F01 Nº SHEETS 13		

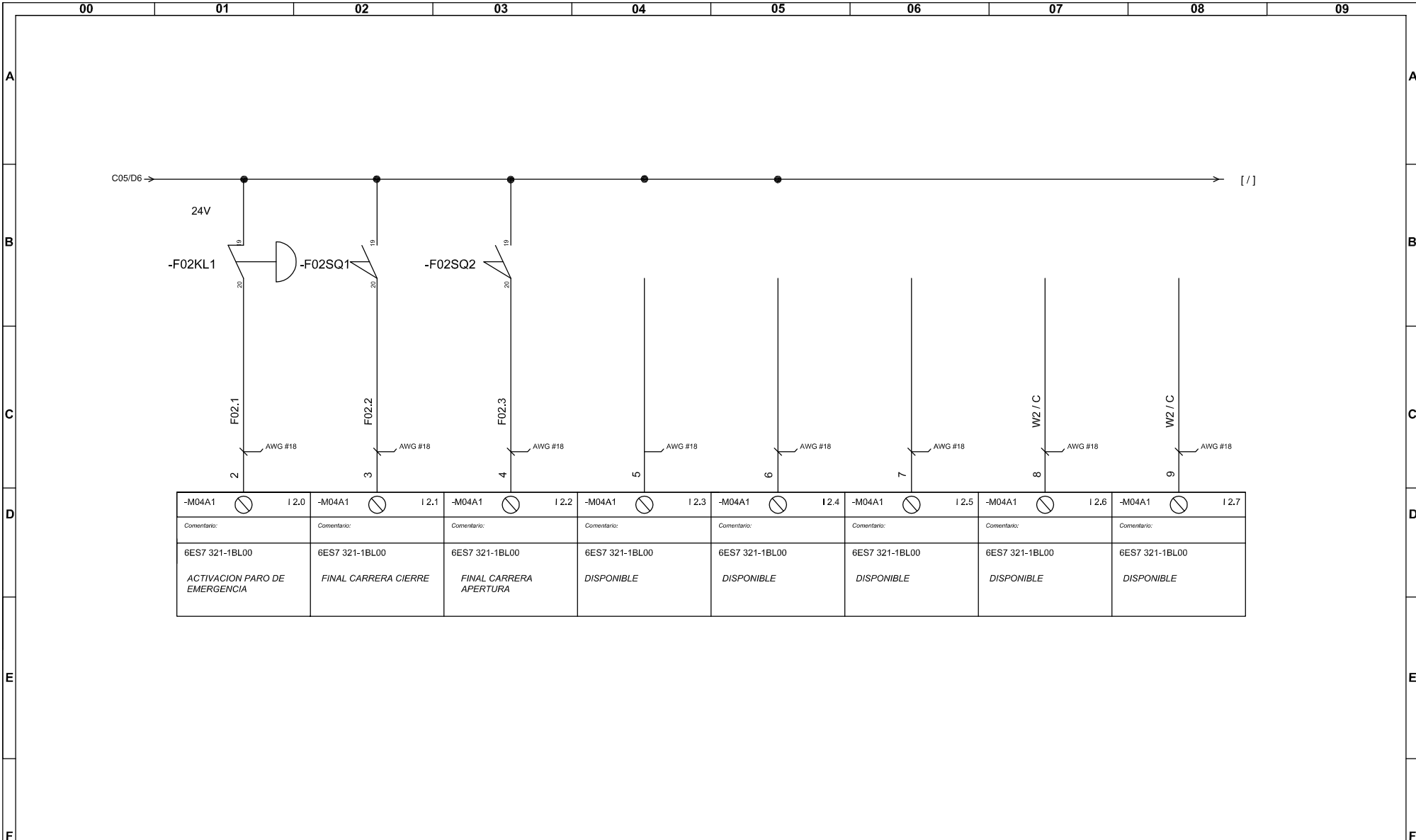

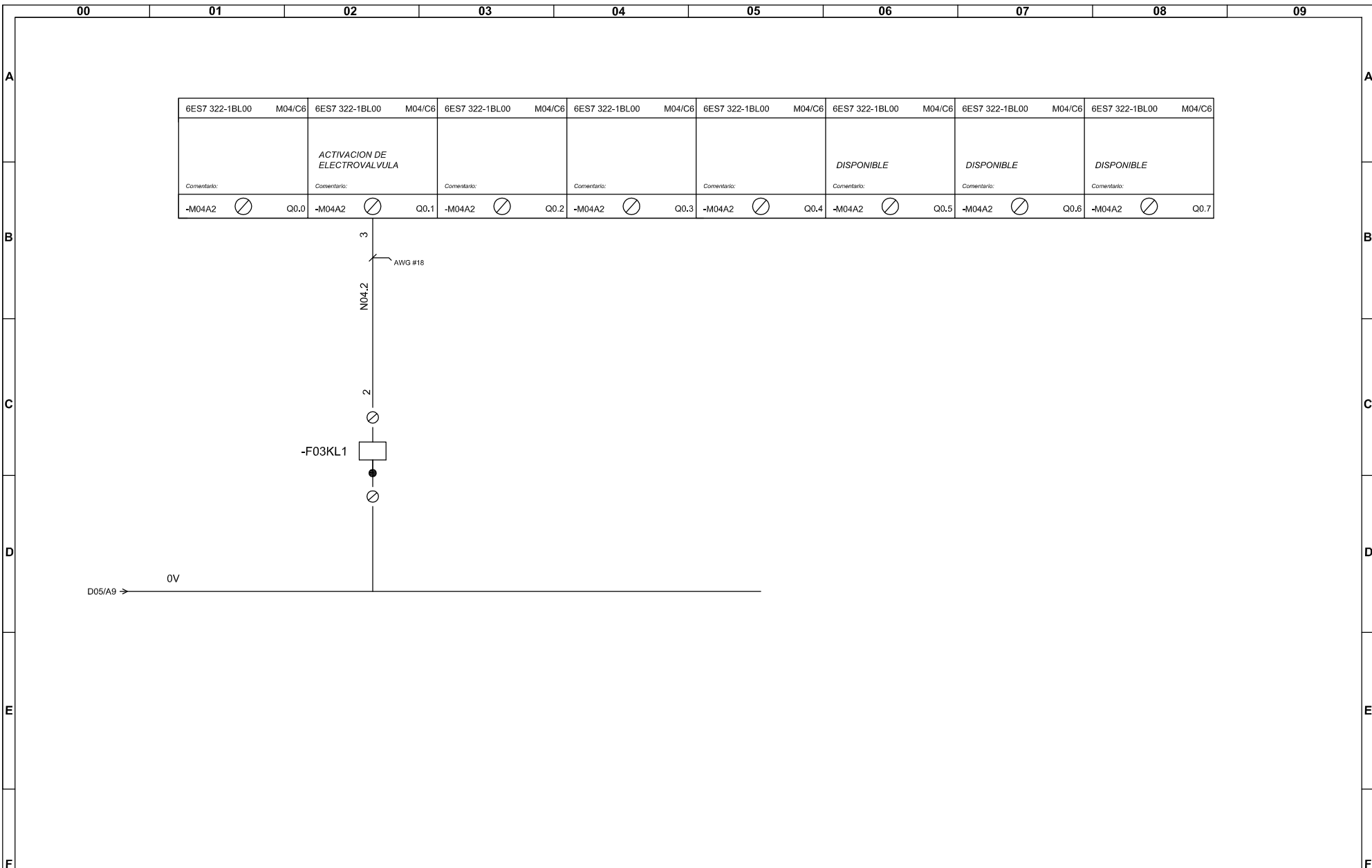

6ES7 322-1BL00	M04/C6	6ES7 322-1BL00	M04/C6	6ES7 322-1BL00	M04/C6	6ES7 322-1BL00	M04/C6	6ES7 322-1BL00	M04/C6	6ES7 322-1BL00	M04/C6	6ES7 322-1BL00	M04/C6	6ES7 322-1BL00	M04/C6
		ACTIVACION DE ELECTROVALVULA								DISPONIBLE		DISPONIBLE		DISPONIBLE	
Comentario:		Comentario:		Comentario:		Comentario:		Comentario:		Comentario:		Comentario:		Comentario:	
-M04A2	Q0.0	-M04A2	Q0.1	-M04A2	Q0.2	-M04A2	Q0.3	-M04A2	Q0.4	-M04A2	Q0.5	-M04A2	Q0.6	-M04A2	Q0.7

				DATE	19/04/2014		ADELCA	P.L.C. SALIDAS DIGITALES SM 322	Plano Sito Pesaje			
				DRAWN	Edgar Taimal				=PS01		SHEET F03 FOLIOV G01	
				CHECK	Edgar Taimal						N° SHEETS 13	
				Appd.								

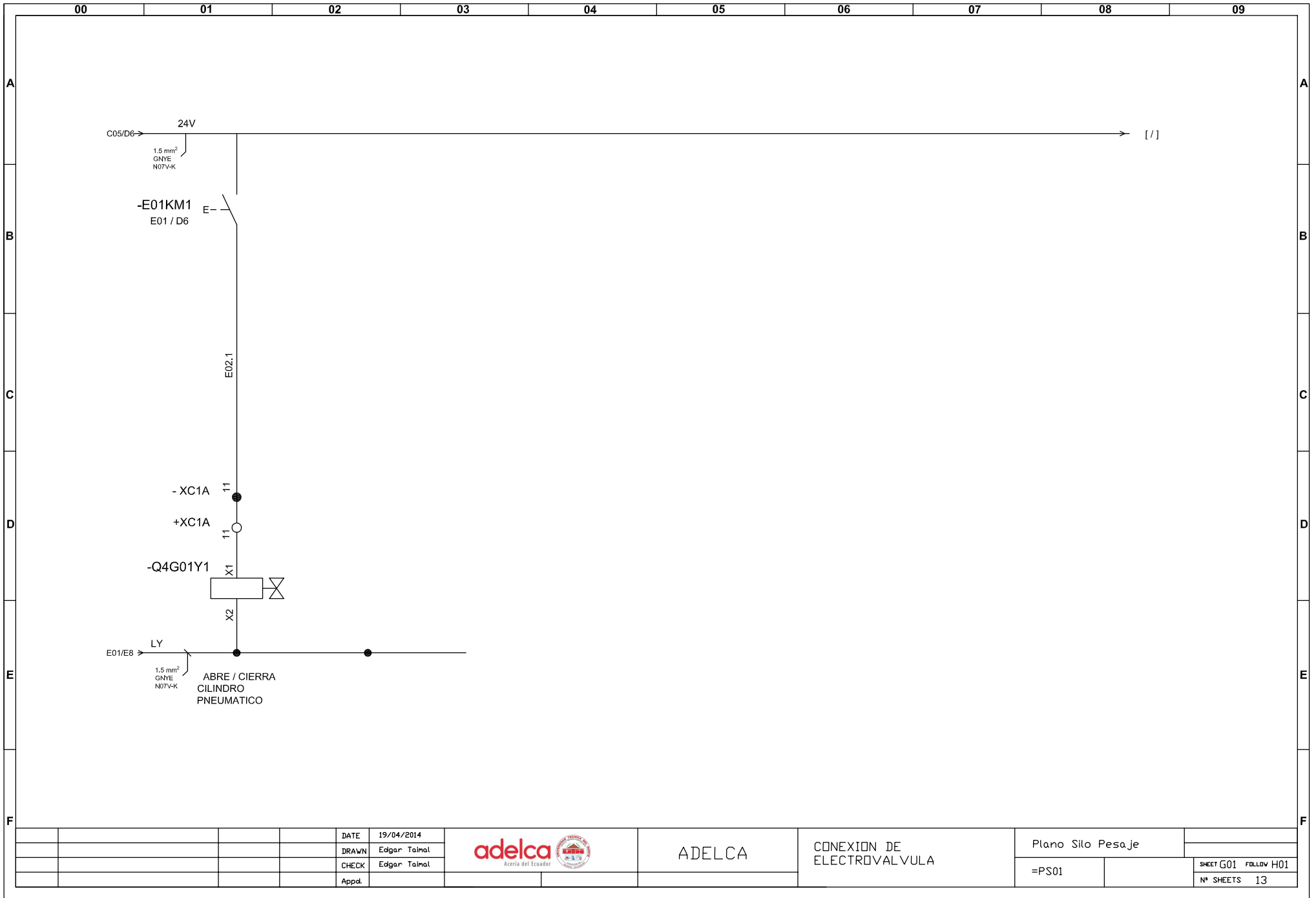

00 01 02 03 04 05 06 07 08 09

A  
B  
C  
D  
E  
F

A  
B  
C  
D  
E  
F

=PS02  
CONEXION CELDAS CARGA

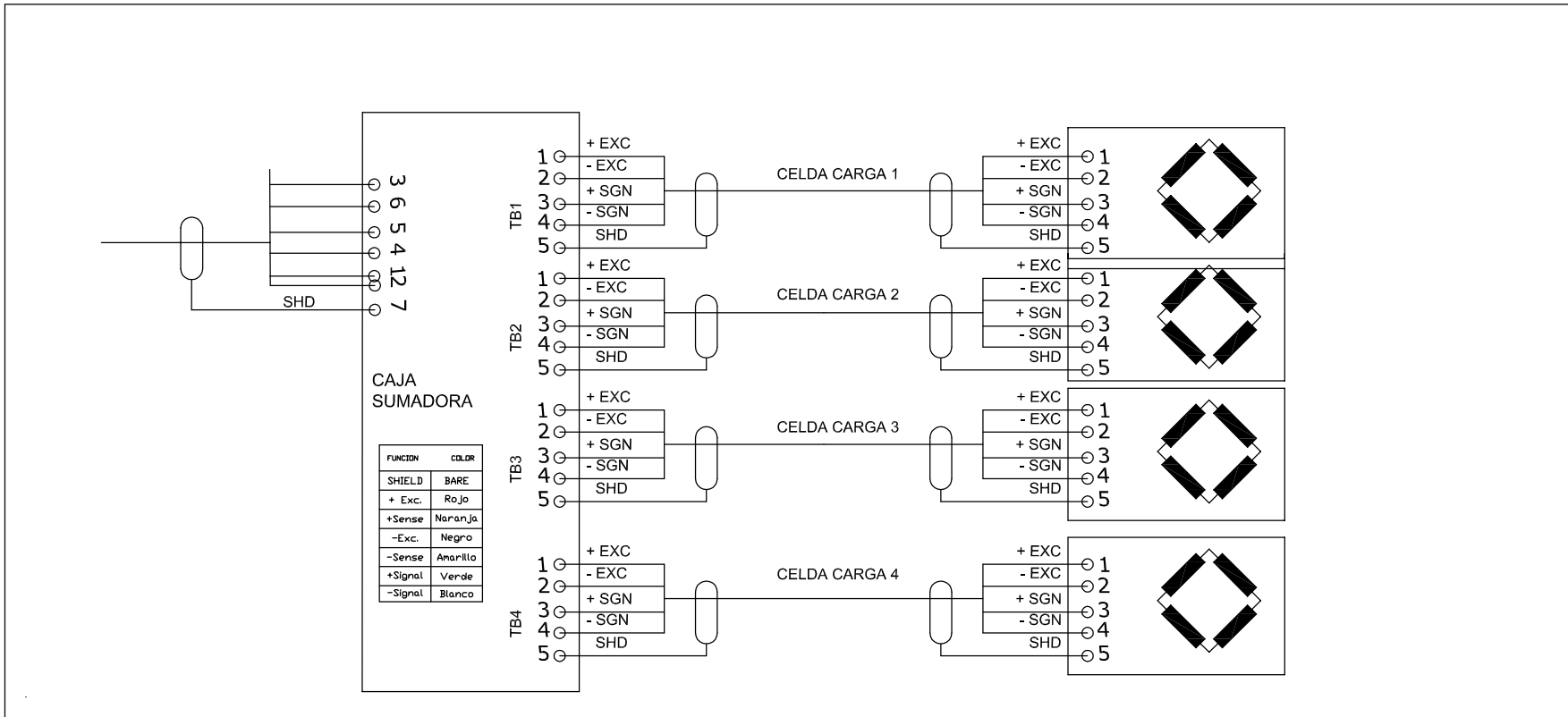

FUNCION	COLOR
SHIELD	BARE
+ Exc.	Rojo
+Sense	Naranja
-Exc.	Negro
-Sense	Amarillo
+Signal	Verde
-Signal	Bianco